

## HF solenoid valves

solenoid valves for power packs and other hydraulic applications



### HF solenoid valves

Hydraulfunktion can offer a small range of solenoid valves, commonly used in hydraulic power packs or other hydraulic applications.



## HF solenoid valves

solenoid valves for power packs and other hydraulic applications

### Cavities

#### cavity 08-02:

HF can supply 2/2 position valve with common industry cavity "08-02" [thread 3/4"-16 UNF with 12,7mm nose]

#### cavity M20-02:

HF can also supply 2/2 position valve with special cavity "M20-02" [thread M20 with 15mm nose]

#### cavity 10-03:

The 3way-2pos valve is with common industry cavity "10-03" [thread 7/8"-14 UNF]

### Products:

pg. 3	SV-08-2-1NC	2way-2pos solenoid valve industry common cavity "08-2" normally closed uni-directional
pg. 8	SV-08-2-1NC M	2way-2pos solenoid valve industry common cavity "08-2" normally closed uni-directional manual override
pg. 12	SV-08-2-2NC M	2way-2pos solenoid valve industry common cavity "08-2" normally closed bi-directional manual override
pg. 16	SV-M20-2-1NC	2way-2pos solenoid valve cavity "M20-2" normally closed uni-directional
pg. 20	SV-10-3-3L M	3way-2pos solenoid valve industry common cavity "10-3" leakage free manual override

All solenoid valves are available with a range of common connectors.  
Hirschman [DIN], M24x1,0, M27x1,0 and AMP junior.

# HF solenoid valve

## SV-08-2-1NC

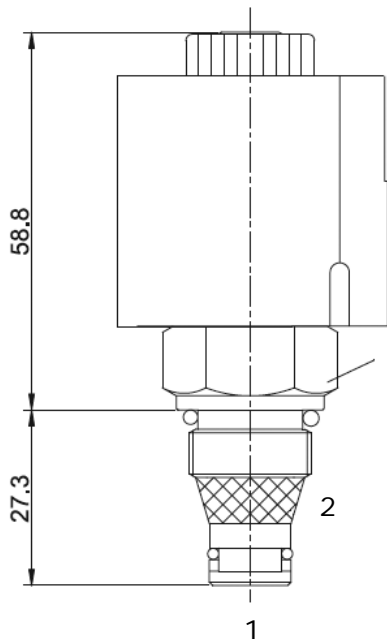

### 2way-2pos solenoid valve

- normally closed
- pilot operated

### Operation:

When de-energized, the valve acts like a check valve and allows from 1 to 2, while blocking flow from 2 to 1.

When energized the poppet lifts and opens the flow path from 2 to 1

### Features

- 250 bar operating pressure
- Filter screen standard
- Industry common cavity [08-2]
- continuous duty solenoids
- optional coil voltages

### Specification

operating pressure:	250bar
internal leakage:	0-2 drops per min.
temperature:	-35° C - +120° C
coil rating:	85% - 110% of rated voltage
cavity:	08-2
fluids:	mineral based fluids
flow characteristics:	see chart

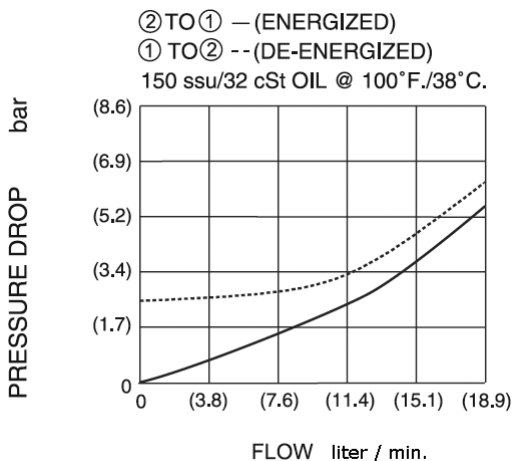
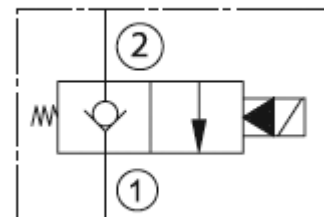

SV-08-2-1NC 12H  
 SV-08-2-1NC 24H



2way-2pos solenoid valve  
 incl. magnet  
 - 12V Hirschman (DIN) contacts  
 - 24V Hirschman (DIN) contacts

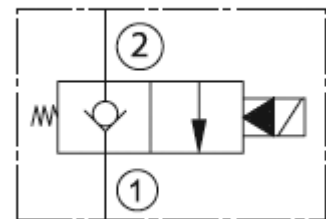

Set consists of  
 1pc valve SV-08-2-1NC  
 1pc nut  
 2pc O-ring  
 1pc magnet  
 12V S2-12-13,25-H  
 24V S2-24-13,25-H

SV-08-2-1NC 12M24  
SV-08-2-1NC 24M24



2way-2pos solenoid valve  
incl. magnet  
- 12V M24x1 contacts

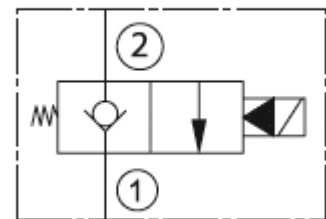

Set consists of  
1pc valve SV-08-2-1NC  
1pc nut  
2pc O-ring  
1pc magnet  
12V S2-12-13,25-M24  
24V S2-24-13,25-M24

SV-08-2-1NC 12M27  
 SV-08-2-1NC 24M27



2way-2pos solenoid valve  
 incl. magnet  
 - 12V M27x1 contacts

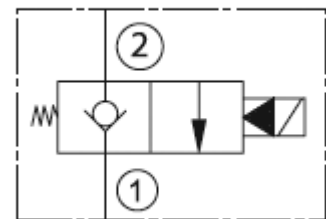

Set consists of  
 1pc valve SV-08-2-1NC  
 1pc nut  
 2pc O-ring  
 1pc magnet  
 12V S2-12-13,25-M27  
 24V S2-24-13,25-M27

SV-08-2-1NC 12AMP  
 SV-08-2-1NC 24AMP



2way-2pos solenoid valve  
 incl. magnet  
 - 12V AMP junior contacts

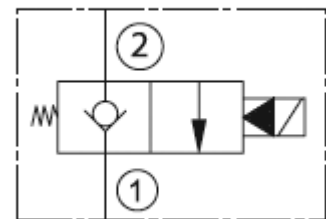

Set consists of  
 1pc valve SV-08-2-1NC  
 1pc nut  
 2pc O-ring  
 1pc magnet  
 12V S2-12-13,25-AMP  
 24V S2-24-13,25-AMP

SV-08-2-1NC M 12H  
SV-08-2-1NC M 24H



2way-2pos solenoid valve  
incl. magnet  
- 12V Hirschman (DIN) contacts  
- 24V Hirschman (DIN) contacts



Set consists of  
1pc valve SV-08-2-1NC M  
1pc nut  
2pc O-ring  
1pc magnet  
12V S2-12-13,25-H  
24V S2-24-13,25-H



SV-08-2-1NC M 12M24  
SV-08-2-1NC M 24M24



2way-2pos solenoid valve  
incl. magnet  
- 12V M24x1 contacts  
- 24V M24x1 contacts



Set consists of  
1pc valve SV-08-2-1NC M  
1pc nut  
2pc O-ring  
1pc magnet  
12V S2-12-13,25-M24  
24V S2-24-13,25-M24

SV-08-2-1NC M 12M27  
SV-08-2-1NC M 24M27



2way-2pos solenoid valve  
incl. magnet  
- 12V M27x1 contacts  
- 24V M27x1 contacts



Set consists of  
1pc valve SV-08-2-1NC M  
1pc nut  
2pc O-ring  
1pc magnet  
12V S2-12-13,25-M27  
24V S2-24-13,25-M27

SV-08-2-1NC M 12AMP  
SV-08-2-1NC M 24AMP



2way-2pos solenoid valve  
incl. magnet  
- 12V AMP junior contacts  
- 24V AMP junior contacts



Set consists of  
1pc valve SV-08-2-1NC M  
1pc nut  
2pc O-ring  
1pc magnet  
12V S2-12-13,25-AMP  
24V S2-24-13,25-AMP

SV-M20-2-1NC 12H  
SV-M20-2-1NC 24H



2way-2pos solenoid valve  
incl. magnet  
- 12V Hirschman (DIN) contacts  
- 24V Hirschman (DIN) contacts



Set consists of  
1pc valve SV-M20-1NC  
1pc nut  
2pc O-ring  
1pc magnet  
12V S2-12-13,25-H  
24V S2-24-13,25-H

SV-M20-2-1NC 12M24  
SV-M20-2-1NC 24M24



2way-2pos solenoid valve  
incl. magnet  
- 12V M24x1 contacts  
- 24V M24x1 contacts



Set consists of  
1pc valve SV-M20-2-1NC  
1pc nut  
2pc O-ring  
1pc magnet  
12V S2-12-13,25-M24  
24V S2-24-13,25-M24

SV-M20-2-1NC 12M27  
SV-M20-2-1NC 24M27



2way-2pos solenoid valve  
incl. magnet  
- 12V M27x1 contacts  
- 24V M27x1 contacts



Set consists of  
1pc valve SV-M20-2-1NC  
1pc nut  
2pc O-ring  
1pc magnet  
12V S2-12-13,25-M27  
24V S2-24-13,25-M27

SV-M20-2-1NC 12AMP  
SV-M20-2-1NC 24AMP



2way-2pos solenoid valve  
incl. magnet  
- 12V AMP junior contacts  
- 24V AMP junior contacts



Set consists of  
1pc valve SV-M20-2-1NC  
1pc nut  
2pc O-ring  
1pc magnet  
12V S2-12-13,25-AMP  
24V S2-24-13,25-AMP

SV-10-3-L 12H  
SV-10-3-L 24H



3way-2pos solenoid valve  
incl. magnet  
- 12V Hirschman (DIN) contacts  
- 24V Hirschman (DIN) contacts



Set consists of  
1pc valve SV-10-3-L  
1pc nut  
2pc O-ring  
1pc magnet  
12V S3-12-16-H  
24V S3-24-16-H





What does HYDRAULFUNKTION stand for?

HYDRAULFUNKTION is dedicated to customer satisfaction. Our goal is to offer our customers

- good service
- good quality products
- a fair price even at low quantities
- the best technical support

HYDRAULFUNKTION is specialized in the production of small and medium size series. We want to give small companies in the vehicle building industry access to products, services and PRICES that are common in the high volume OEM markets.

We know, that small manufacturers in the vehicle building are doing a wonderful job; innovative and flexible. We want to support this type of company.

If you have any ideas, questions or problems, please don't hesitate to contact HYDRAULFUNKTION AB.

HYDRAULFUNKTION AB  
Kungsgatan 67  
S-341 32 Ljungby  
hf@hydraulfunktion.se  
Tel.: +46(0)372-15840  
Fax.: +46(0)372-15843

## Other HF products

HYDRAULFUNKTION is manufacturing dc hydraulic power pack and hydraulic components. This includes 3 main product groups

### Dc box power packs

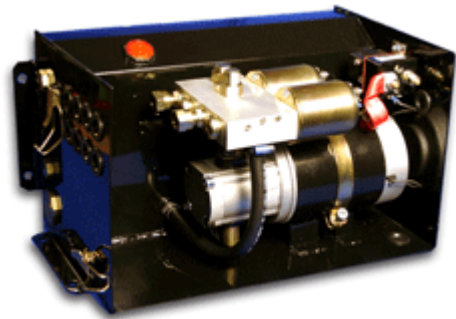

### Dc compact power packs



### Dc motor-pump units

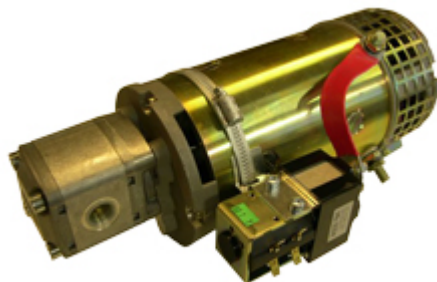



## Impress

General:

This catalogue has been written with greatest concerns. Still it can contain errors and mistakes. For errors and mistakes the author can nor be made legally liable.

Layout and content:      Hydraulfunktion GmbH

Version:                      09.0528

Publishing date:          28. Mai 2009

**HF**  
*power Packs*

For mobile hydraulics

## Contact

### **Hydraulfunktion AB Production / Supplier**

Kungsgatan 67  
(S) 341 32 Ljungby  
Sweden

Tel: +46 (0)372 - 15840

Fax: +46 (0)372 - 15843

Email: [hf@hydraulfunktion.se](mailto:hf@hydraulfunktion.se)